

Eco Preparation 1600 mm Work Table - disassembled

ITEM # _____

MODEL # _____

NAME # _____

SIS # _____

AIA # _____



132842 (WTD1607N)

 Work Table disassembled,
1600mm

Short Form Specification

Item No. _____

Worktop in 304 AISI stainless steel with upturned edges and under panel made of sound deadening material. Square section legs 40x40mm in 304 AISI stainless steel with adjustable feet. Delivered disassembled.

Main Features

- The table can be ordered with the drawer of 400 mm or 600 mm (optional accessory): thanks to the design of the drawer, additional drawers can be added to the first single drawer to create chest of 2, 3 or 4 drawers based on customer's needs.
- Sturdiness, stability and reliability of table accurately tested.

Construction

- Delivered in knock-down package.
- Constructed entirely in stainless steel to offer maximum durability.
- Wide range of taps are available to suit every need.

Optional Accessories

- Lower shelf for 1600mm tables and sinks PNC 855147
- Set of 4 wheels (2 with brake) d. 100mm for tables and sinks (total height on wheels= 993 mm) PNC 855150
- 3-sided underframe for 1600mm tables PNC 855154

APPROVAL: _____

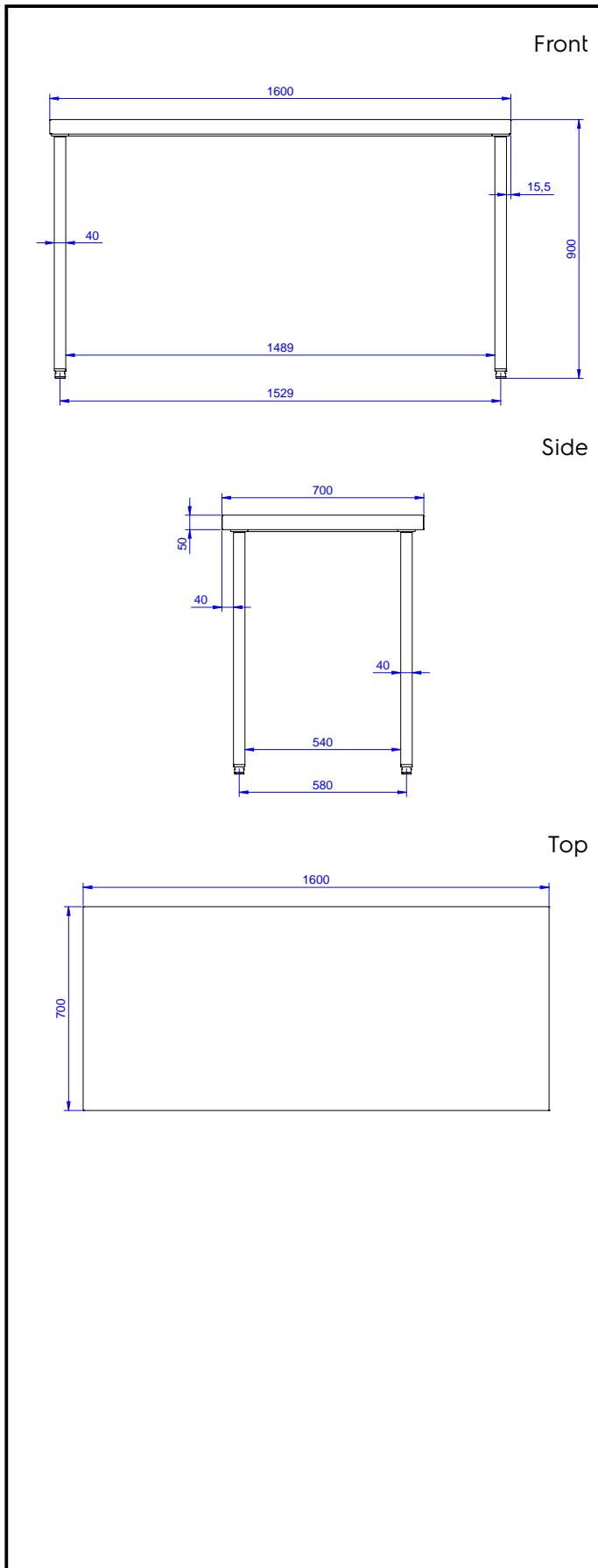

Key Information:

External dimensions, Width:	1600 mm
132842 (WTD1607N)	1600 mm
External dimensions, Depth:	700 mm
External dimensions, Height:	900 mm
Worktop thickness:	50 mm
Net weight:	53 kg